

Design and Testing of a Sensitive Heat-Flow Calorimeter for Measuring Radioactive Waste in 55-Gallon (US) Drums -15334

John A. Mason*, Charles Bonner**, Kevin J. Burke*, Lynn Foster**, Lawrence V. Odell*, James M. Pecos**, Barry. M. Scott*, Antony C. N. Towner*, Michael J. West* and Graeme H. Wood*

*ANTECH, A. N. Technology Ltd., Unit 6, Thames Park, Wallingford, Oxfordshire, OX10 9TA, UK

**Los Alamos National Laboratory, Los Alamos, New Mexico, 87545, USA

ABSTRACT

A sensitive large volume calorimeter for measuring the thermal power generated by the radioactive decay of heat producing materials in 55-gallon drums has been developed and tested. The technology is applicable to the measurement of all radionuclides that decay by alpha or beta decay such as waste or product material containing plutonium, tritium and americium. It is also relevant to the measurement of drums where gamma rays from radioactive decay are captured locally in attenuating materials and the resulting rate of thermal energy deposition (sample thermal power) is of sufficient magnitude for a calorimetry measurement. The initial application of the drum calorimeter is for measuring and characterizing plutonium-bearing waste drums. The calorimeter design has optimised the two characteristics of high thermal sensitivity and reduced measurement times. In order to achieve these characteristics for large volume drums, the heat-flow method of operation was chosen in a single measurement chamber configuration. Using a drum-lifting device, the waste drum is positioned on a sliding platform and subsequently moved by the operator inside an octagonal inner chamber, which acts as the heat sink. The heat-sink chamber has significant thermal inertia and remains effectively at a constant temperature throughout the duration of a drum measurement. The octagonal inner measurement chamber is constructed inside a multi-layer external thermal enclosure, which provides both thermal insulation and significant thermal inertia. The external thermal enclosure isolates the measurement process from the effects of changes in the external ambient temperature. During a measurement, heat flows from the drum being measured to the heat sink. This heat-flow is measured by a series of thermopile sensor assemblies, which are positioned between the waste drum and the heat sink. A high sensitivity of greater than 200 $\mu\text{V}/\text{mW}$ (microvolts per milliwatt) has been achieved using multiple close-coupled thermopile sensors in each assembly. Reduced measurement times are achieved by positioning the thermopile sensor assemblies close to the drum surface in order to reduce the thermal transport delay. The instrument incorporates a calibrated precision power supply, which requires annual recalibration and is traceable to national standards. It is used to power a calibration heater that has been built into a calibration and test drum. The calibration and test drum is used both to calibrate the instrument and provide periodic confirmation of correct operation. Measurements of calorimeter performance are reported for a range of drum thermal powers. Long-term temperature drift measurements are used to provide estimates of the minimum detectable drum thermal power and hence the minimum detectable activity for both plutonium and tritium.

INTRODUCTION

The purpose of the calorimeter is to measure the thermal power generated by the radioactive decay of heat producing radionuclides in 55-gallon (US) drums. The technique is applicable to heat producing heterogeneous radioactive waste where gamma ray absorption or a high

gamma ray dose-rate precludes a direct gamma ray assay measurement. Alternatively, calorimetry may be employed to measure and assay transuranic waste drums with a high activity due to alpha-n reactions or a strongly moderating matrix, where neutron assay measurements are not possible. In these cases, radiometric calorimetry provides a measurement method, which is accurate and independent of the waste matrix in the drum.

The two principle types of radiometric calorimeters are described as either of the Isothermal or of the Heat-flow type [1]. Isothermal calorimeters [2, 3] employ servo-control and use the power replacement mode of operation. Measured electrical power (called the Base Power) is applied to the measurement chamber (cell) in order to maintain a constant temperature profile within the measurement chamber. Following the insertion of a heat-producing sample, the servo control mechanism reduces the applied electrical power necessary to maintain the constant temperature profile, in such a way that the thermal power of the sample replaces the applied electrical power. When thermal equilibrium is reached, the difference in the applied electrical power is a measure of the thermal power of the sample – hence the description “power replacement mode”.

In contrast, improved precision and accuracy can be achieved with Heat-flow calorimeters, which have higher sensitivity but with longer measurement times [4,5]. In this type of measurement a linear relationship exists between the output signal of the heat-flow sensors of the measurement chamber and the thermal power of the measured sample. The instrument is calibrated by introducing known quantities of thermal power, which are completely equivalent to electrical power delivered to an electrical heater within the measurement chamber. Using this approach the linear calibration coefficient can be expressed as the calorimeter sensitivity, typically in units of microvolts per milliwatt ($\mu\text{V}/\text{mW}$).

Heat-flow calorimeters often employ twin cells – both a measurement chamber or cell and a reference chamber for compensation. Improved precision is achieved in the twin cell configuration where the output signal of the reference cell is subtracted from the output signal of the measurement cell. Common mode effects such as disturbances caused by variations in the ambient environmental temperature are thus eliminated. Due to both the size and cost of a reference cell, one has not been included in the present design. An alternative compensator, based on the deployment of additional heat-flow sensors, has been included in order to improve stability of the measurement chamber.

There are two important requirements and objectives for waste drum measurement by calorimetry. The first is high thermal sensitivity due to the relatively low thermal output of most radioactive decay processes. The second is a short measurement time due to the long time constants for heat-transfer typically due to transport delays in thermal energy reaching heat-flow or temperature sensors. In the present design multiple parallel thermopile heat-flow sensors have been employed to enhance the signal to noise ratio and thus improve the sensitivity of the instrument. The problem of long measurement times has been addressed by positioning the thermopile heat-flow sensors as near as possible to the surface of the waste drum. The heat-transfer transport delay problem is minimized by close coupling the sensors and the drum surface. An objective has been to reduce measurement times to below 24 hours.

Measurements have been made of the performance of the drum calorimeter based on the use of an electrically heated test drum, which simulates a heat producing radioactive waste drum. The instrument has been electrically calibrated and the sensitivity determined. A long-term drift measurement has been used to estimate the minimum detectable thermal power for a waste drum. Estimates have been made of both the measurement precision and accuracy and typical

measurement times to reach thermal equilibrium have been determined.

DESIGN

In Fig. 1, which shows the model CHF550-20800 Heat-flow Drum Calorimeter, the thermal element is on the left and the control electronics are on the right. The measurement and control electronics, consisting of a sensitive digital voltmeter, scanner and source meter are housed in the calorimeter instrument rack, along with the control computer.



Fig. 1. Model CHF550-20800 Heat-flow Drum Calorimeter.

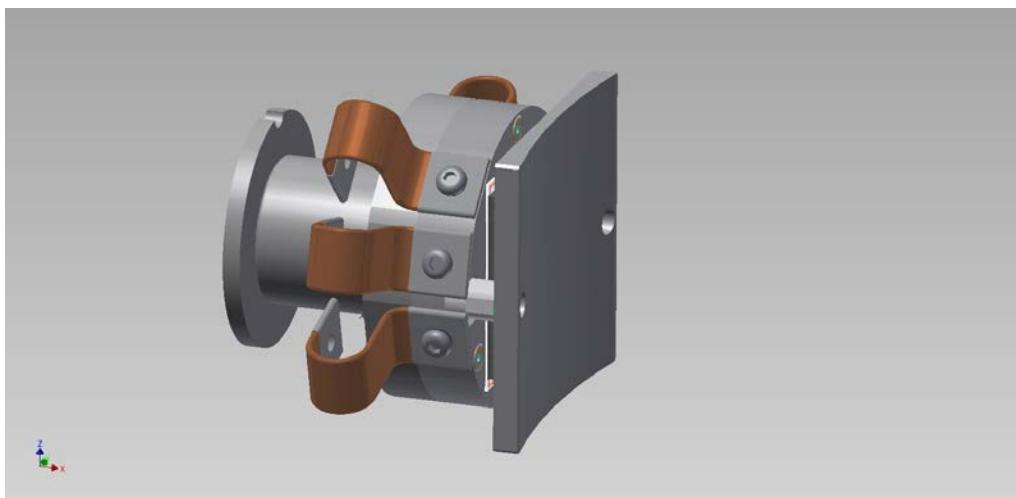

Fig. 2. Thermopile Heat-flow Sensor Assembly (TSA).

At the core of the calorimeter design is the Thermopile Heat-flow Sensor Assembly (TSA). This component is the means by which the two objectives of high sensitivity and the close coupling of the heat-flow sensors to the surface of the drum have been achieved. Figure 2 shows a view of the (TSA). It consists of a series of thermopile heat-flow sensors connected in series and positioned between a curved coupling plate and a cylindrical heat sink component, both of

which are fabricated from aluminium. The curved coupling plate couples the sensors to the surface of the drum and the plate is machined with a profile to provide good heat transfer coupling to the drum surface.

The other surface of the series of thermopile heat-flow sensors is coupled to a cylindrical heat sink component. The cylindrical heat sink component slides (under the force of a spring) along a shaft, which is mounted on the main heat sink chamber assembly. This chamber assembly, which is made of large aluminium plates, forms an octagonal enclosure or measurement chamber into which a radioactive waste drum is inserted. A total of 46 TSAs are fixed to the main heat sink chamber assembly and when a drum is inserted and the assembly is closed around the drum, the curved plates of the TSAs come into close physical contact with the drum surface. Figure 3 is a photograph of the Drum calorimeter with drum inserted into the octagonal heat sink chamber assembly.



Fig. 3. Drum calorimeter with drum inserted into the octagonal heat sink chamber assembly in the open or loading/unloading position.

When a drum is located in the measurement position and the octagonal heat sink is closed around the drum, a measurement of the thermal power of the drum can proceed. Heat or thermal energy flowing from the surface of the drum through the TSA to the octagonal heat sink chamber assembly generates a temperature difference across the sensors of the TSA. Copper braid is used to improve the thermal coupling between the cylindrical heat sink components of each TSA and the octagonal heat sink chamber assembly. This temperature difference generated across the heat-flux sensors of each TSA results in a voltage and when thermal equilibrium is reached, the sum of the voltage output of all of the TSA units is proportional to the

thermal power of the waste drum.

The octagonal heat sink chamber assembly is located inside a substantial and well-insulated thermal shield. The thermal shield isolates the calorimeter measurement chamber and the TSAs from variations of the ambient temperature.

CALIBRATION AND MEASUREMENT RESULTS

The calorimeter was calibrated over two ranges; a low power range of applied thermal power of up to 1.0 Watt and a higher power range of up to 18 Watts to optimise the calorimeter performance. The appropriate calibration range is automatically applied a short period after the start of the measurement. The low power calibration data is plotted in Figure 4.

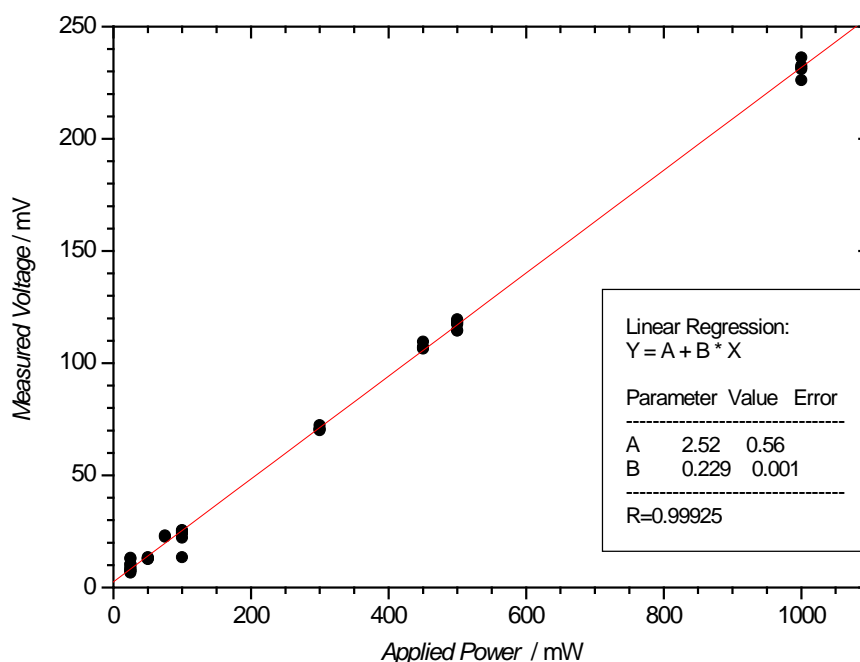

Fig. 4. Drum Calorimeter low power calibration data for thermal powers up to 1.0 Watt showing the measured output voltage from the TSA units plotted as a function of the electrical power applied to the heating element in the test and calibration drum. Note that the calibration is linear due to the linear response of the heat-flow sensors.

The drum calorimeter has been calibrated using an electrical heat standard, which consists of a suitably modified 55-gallon (US) drum with an internal electrical resistance-heating element. Electrical power is supplied to the heat standard through a thermally isolated electrical connector. The electrical power for calibration and performance check measurements is provided by a controlled precision power supply built into the calorimeter instrument rack. It is calibrated on an annual basis and the calibration is traceable to international electrical standards.

From the slope of the linear fit to the low power calibration data we determine the calorimeter sensitivity of 229 $\mu\text{V}/\text{mW}$. This value confirms that the calorimeter meets the design objective of high sensitivity.

A high power calibration has been performed up to a thermal power of 18 Watts. The data is plotted in Figure 5.

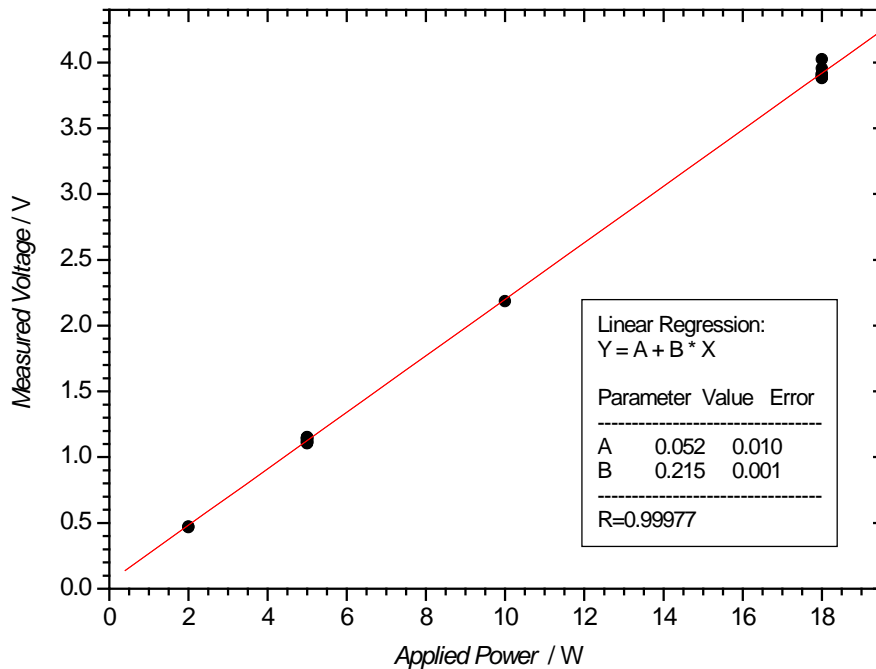

Fig. 5. Drum Calorimeter high power calibration data for thermal powers up to 18.0 Watt.

Above a thermal power of about 1.0 Watt, the power liberated into the measurement chamber raises the octagonal heat sink measurement chamber temperature due to insufficient heat capacity in the heat sink. This effect was anticipated during the design process and as a result a compensator was implemented to improve the thermal stability of the measurement chamber. Although the compensator corrects the effect, the slope of the calibration curve for higher-powered drum measurements is altered. As a result and to improve measurement results, both low and high power calibration functions have been implemented in the drum calorimeter software. The data for a typical measurement for a 5-Watt input thermal power is shown in Figure 6.

Drum calorimeter stability was estimated by measuring the drift in the output voltage signal over 24 hours. The data is plotted in Figure 7.

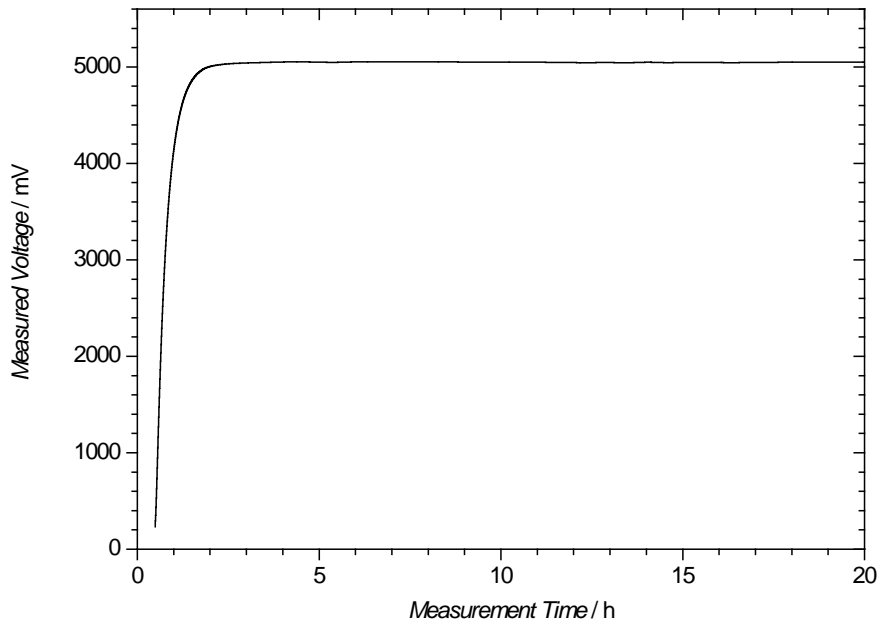

Fig. 6. The data for a typical drum calorimeter measurement for a 5-Watt input thermal power.

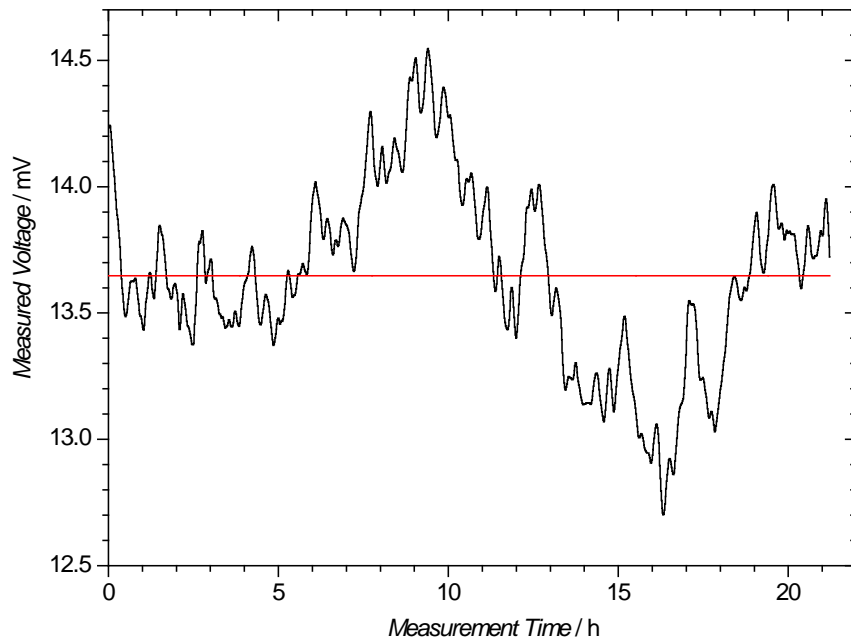

Fig. 7. Drum calorimeter stability as estimated by measuring the drift in the output voltage signal over 24 hours.

The average value of the drift voltage is 13.647 mV and the maximum variation over the 24-hour period is 1.845 mV. Considering the sensitivity of the instrument of 229 $\mu\text{V}/\text{mW}$, this underlying variation in output voltage corresponds to a variation in measured drum thermal power over the 24-hour period of about 8.2 mW (peak to peak). This would appear to represent a lower limit of detection of drum thermal power. The source of this variation is unclear but a contributing factor, which reduces calorimeter measured voltage stability, is believed to be electronic noise generated in the junctions of the thermopile sensors. This so called Schottky noise produces an increasing random effect as the number of junctions is increased. As the calorimeter contains in excess of 47,000 thermocouple junctions, Schottky noise will make a significant contribution to low-level electrical noise.

During routine operation, where the measurement chamber (the octagonal heat sink chamber assembly) is opened and closed to load and unload drums, room temperature variations will have a more significant effect. During factory testing the room temperature varied by as much as 5 degrees Centigrade per day and it is calculated that such temperature variations would lead to a variation in measured drum thermal power of as much as 34 mW (peak to peak).

Drum calorimeter measurement times are reported in Figure 8.

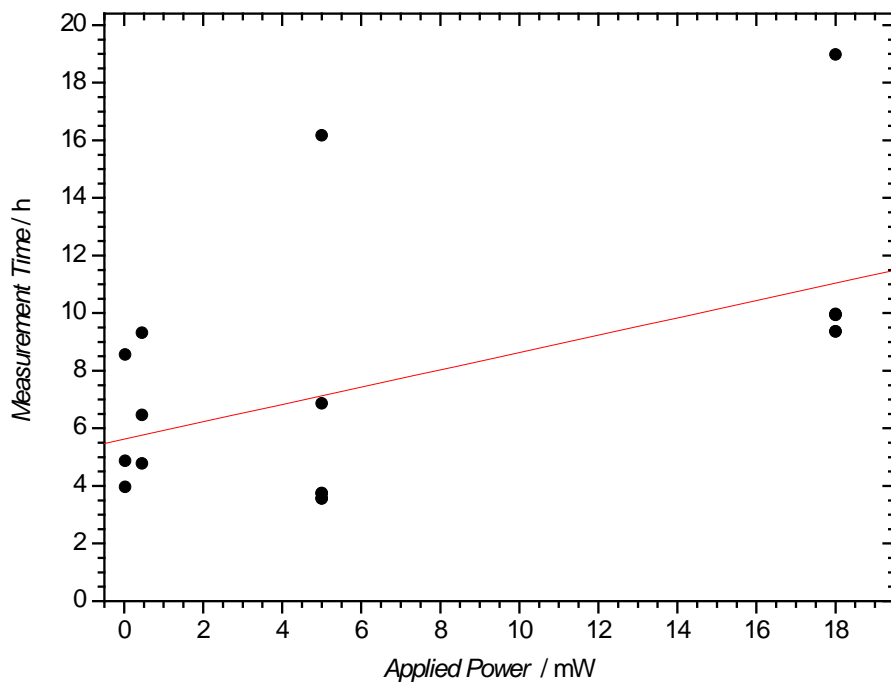

Fig. 8. Drum calorimeter measurement times (to thermal equilibrium) as a function of measured thermal power.

Drum calorimeter measurement precision and accuracy are reported in Figures 9 and 10.

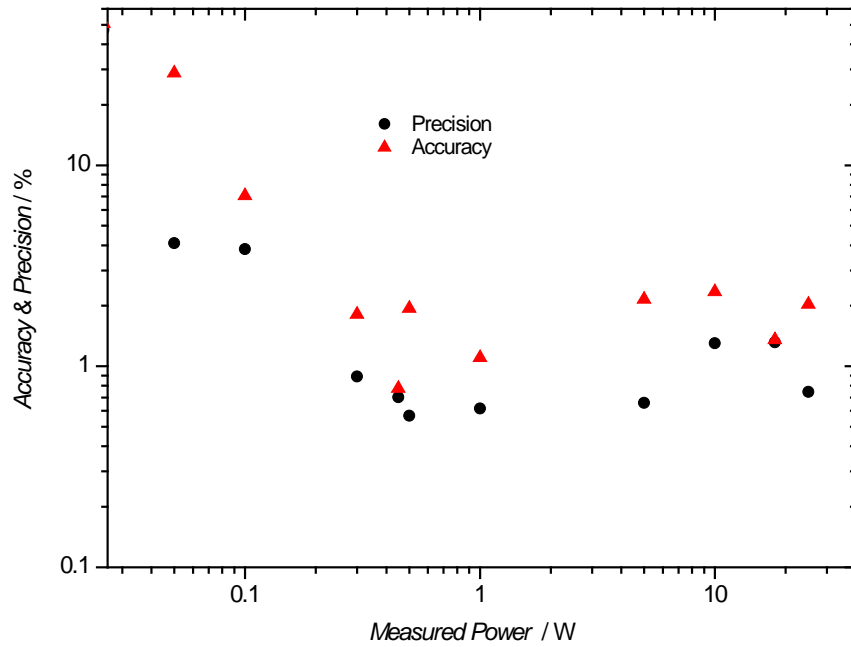

Fig. 9. The precision and accuracy (deviation) of the measured drum thermal power as a function of applied electrical power is plotted as percentage values on a log – log scale.

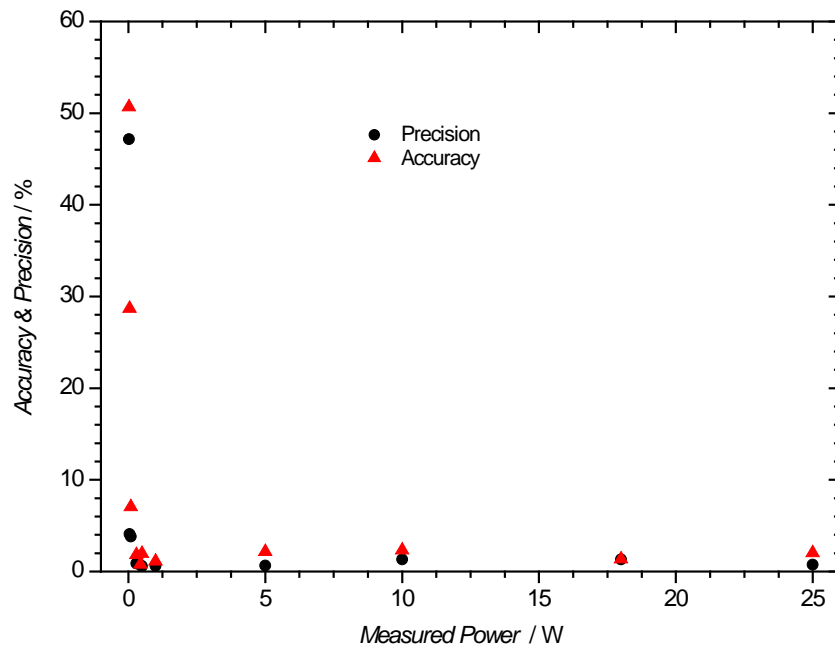

Fig. 10. The precision and accuracy (deviation) of the measured drum thermal power as a function of applied electrical power is plotted as percentage values on a linear scale.

From the data in Figure 8 it is clear that the second objective of short measurement times has been achieved by the drum calorimeter, with an average time to thermal equilibrium of about 8 to 12 hours for a drum which is well temperature conditioned. It is anticipated that drums to be measured will be in thermal equilibrium at room temperature and hence in thermal equilibrium with the calorimeter.

The precision and accuracy (deviation) of the measured drum calorimeter thermal power as a function of applied electrical power is plotted as percentage values on log – log and linear scales in Figures 9 and 10. These two different ways of displaying the data provide a clearer picture of the performance of the instrument. For measured power above 100 mW the precision is about or below 1% and the accuracy is typically about 2%. Below a measured power of 100 mW the precision and accuracy are degraded and at 25 mW are typically about 50%.

As an example of the practical drum calorimeter performance, the measured precision at 50 mW thermal power in a drum is about 4% with an accuracy or error of about 30%. This thermal power corresponds to about 20 g of A-Grade Pu (6% Pu-240) or about 10 g of commercial or O-grade Pu (roughly 20% Pu-240) in a drum. It also corresponds to about 0.1 g of Pu-238 or about 0.15 g of tritium in a drum. In order to put these values in context, for a 55-gallon (200 litre) drum with a density of 1 g/cc, the quantity of A-grade Pu in a drum at the LLW/Transuranic (TRU) threshold of 100 nCi/g is 0.24 g. This quantity of Pu would generate a thermal power output of approximately 629 μ W/drum.

CONCLUSIONS

This paper describes the design and presents performance results for a calorimeter designed to measure the thermal output of 55-gallon (US) drums. The design meets the two objectives of high sensitivity and short measurement times.

A sensitivity of 229 μ V/mW is achieved with an underlying minimum detectable thermal power (MDP) of about 8 mW. In practice, with variations of room temperature of typically 5 degrees Centigrade the minimum detectable thermal power rises to about 35 mW. This level of error explains why the measurement precision and accuracy at the low measured power level of 25 mW rises to about 50%. In the more stable thermal environment where the calorimeter will operate, improved measurement precision and accuracy are anticipated.

Short average measurement times to reach thermal equilibrium of about 8 to 9 hours are reported. These results represent a significant improvement in performance compared to other drum and large volume calorimeters. The improved measurement times make the drum calorimeter a more useful and practical instrument for waste measurement.

With both high sensitivity and short measurement times the drum calorimeter has the potential for measuring a wide range of radioactive waste drums in the “difficult to measure” category, where both gamma ray and neutron assay measurement techniques fail.

REFERENCES

1. J. A. Mason, “The Use of Calorimetry for Plutonium Assay”, *UKAEA Report SRDP-R100*, Safeguards R & D Project, December 1982.
2. J. A. Mason, “Advances in Isothermal Calorimetry for Plutonium Assay,” *Proceedings of the 4th International Conference on Facility Operations - Safeguards Interface*, Albuquerque, 29th September - 4th Oct. 1991, p251-254.

3. J. A. Mason, A. C. N. Towner, B. M. Scott, K. J. Burke and A. C. Tolchard, "Isothermal Calorimeters Applied to the Measurement of Plutonium Residues for Plant Post Operational Clean-out," *Proceedings of the International Conference on Environmental Remediation and Radioactive Waste Management 2003*, Examination School, Oxford, England, September 2003.
4. J. A. Mason, K. J. Burke, N. J. Challacombe, A. R. Packman and A. C. N. Towner, "Design and Operation of a Large Volume Twin Cell Heat-flow Calorimeter for the Measurement of both Tritium and Plutonium Samples," *Proceedings of the 50th Annual Meeting of the Institute of Nuclear Materials Management*, Tucson, Arizona, USA, July 2009.
5. J. A. Mason, Kevin J. Burke, Tom M. B. Jennings, Curtis C. Keener, Katherine B. Mejias, Barry. M. Scott, Antony C. N. Towner and Graeme H. Wood, "*Design and Performance of a Sensitive Multi-Mode Calorimeter for Single Cell Isothermal or Single and Twin Cell Heat-Flow Measurements of Plutonium or Tritium-14003*", Proceedings of WM2014 Symposium, March 2 – 6, 2014, Phoenix, Arizona, USA. (WM14-14003)

ACKNOWLEDGEMENTS

The authors wish to thank Marc Looman for technical advice on data analysis and assistance with the preparation of graphs and Les Clarkson for assistance with the electrical design.